

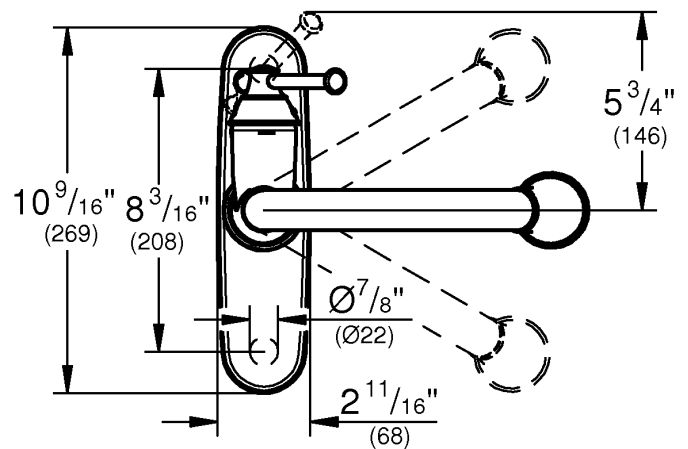

30 210

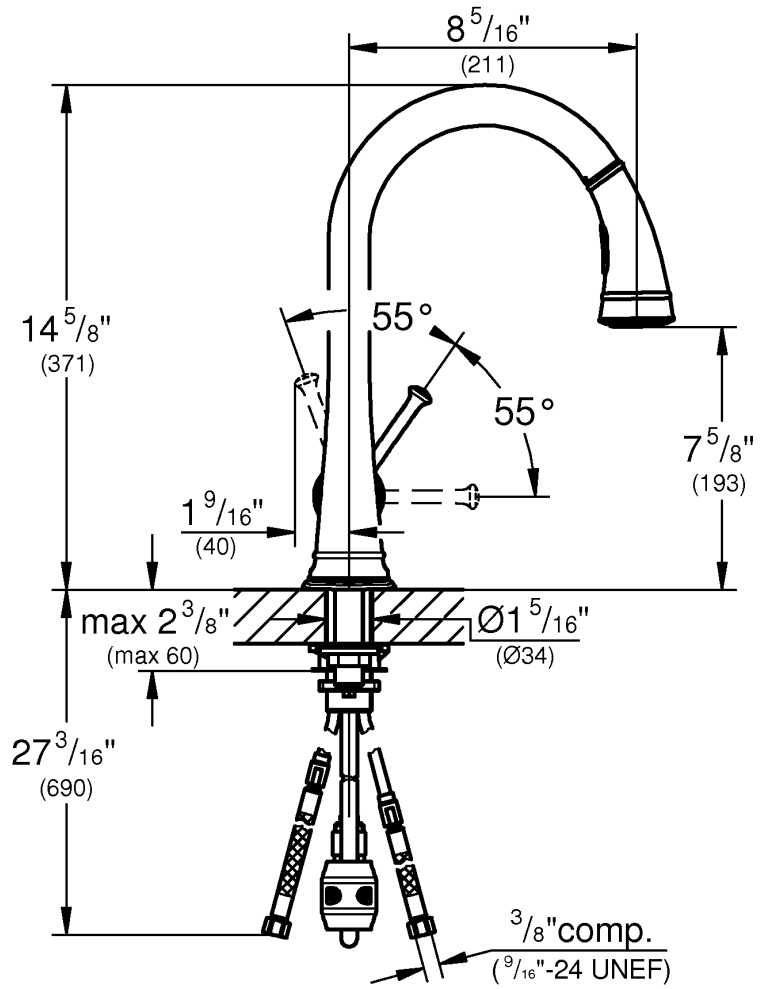

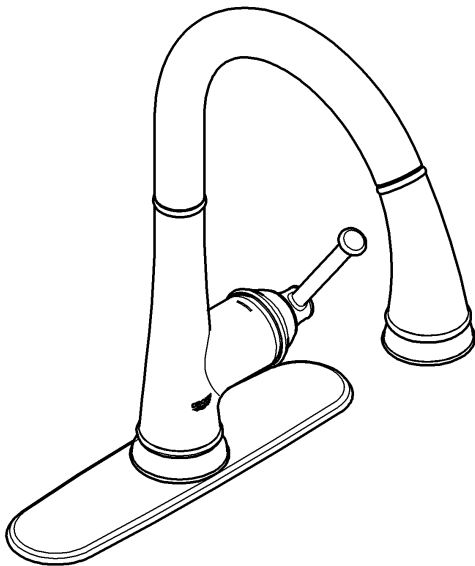
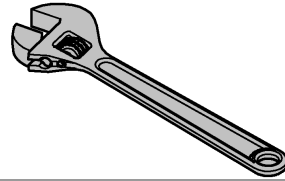
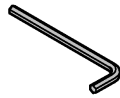
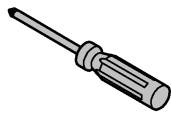
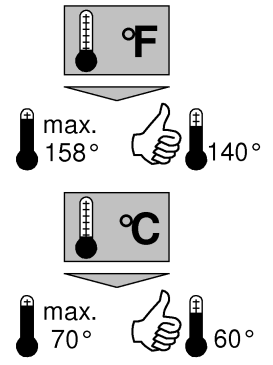
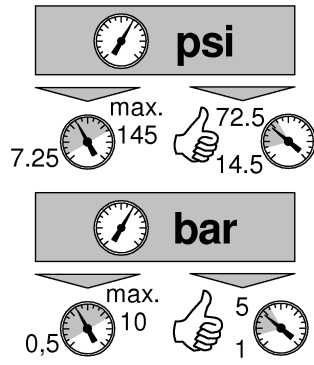
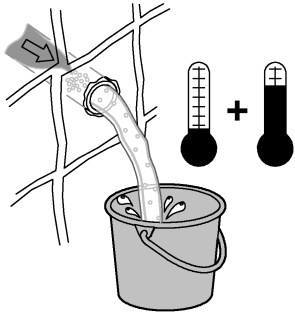

1

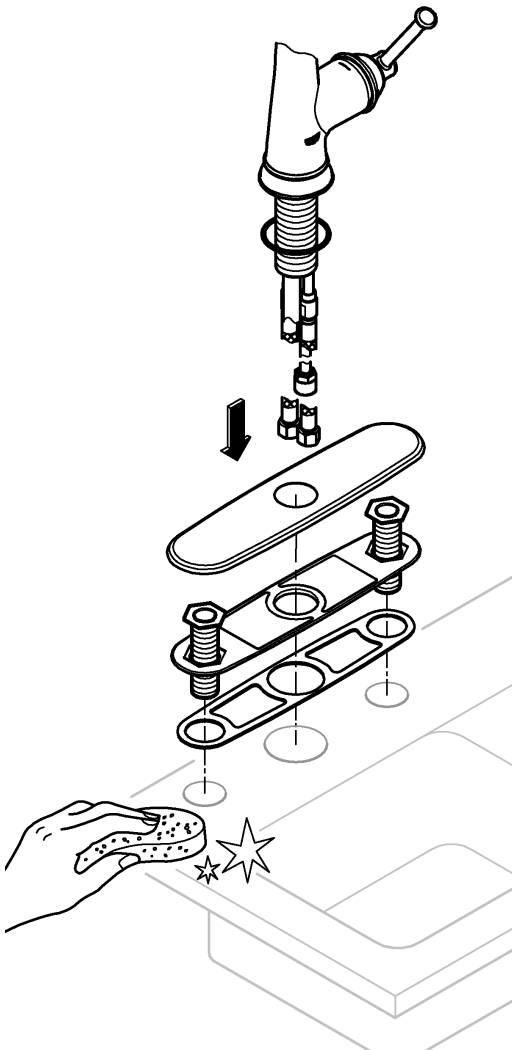

2

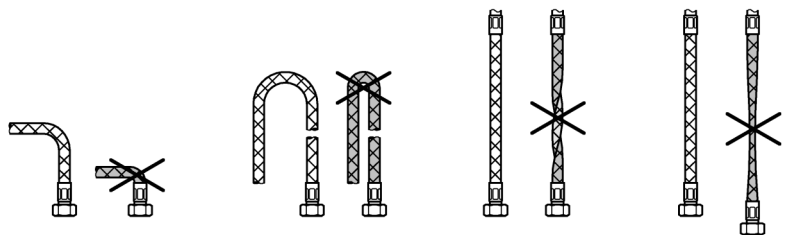
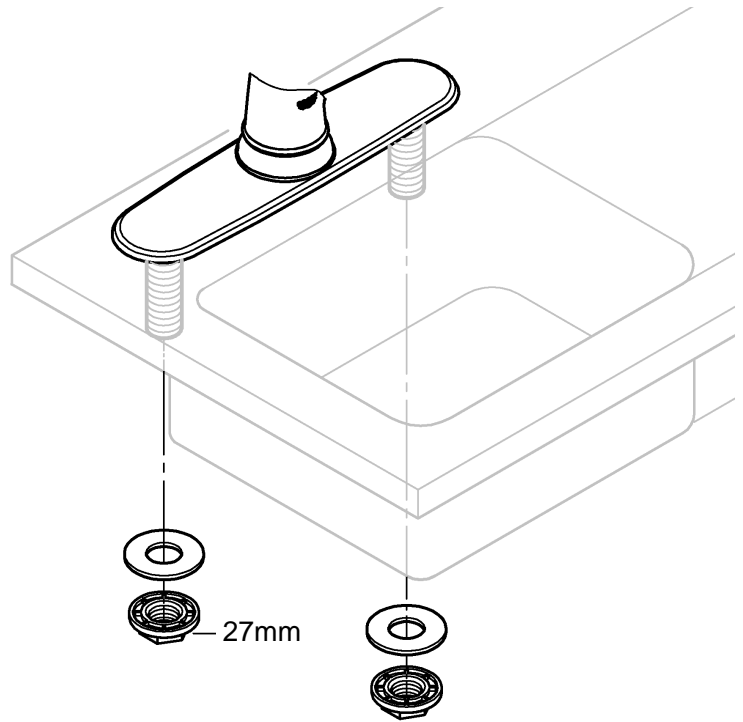



3

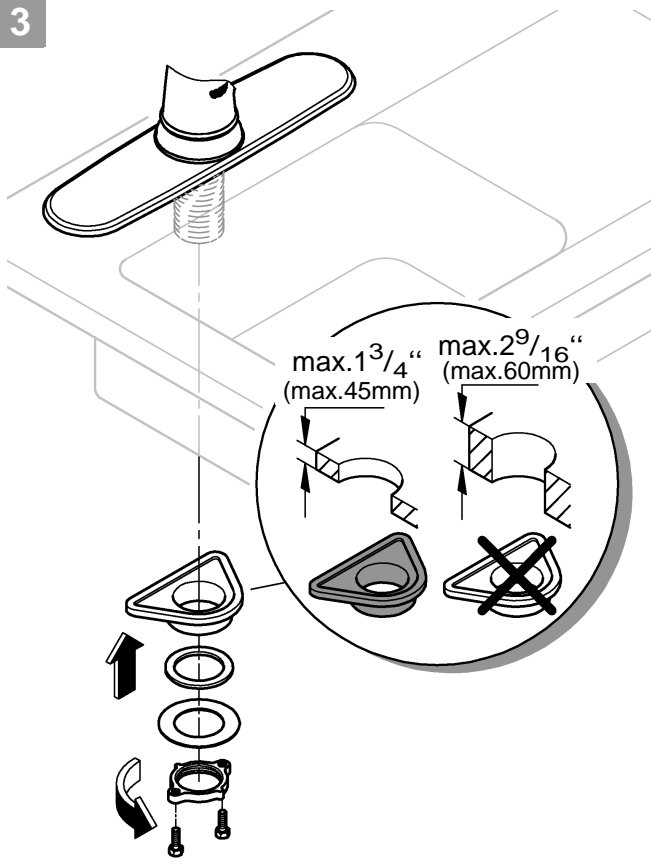

4

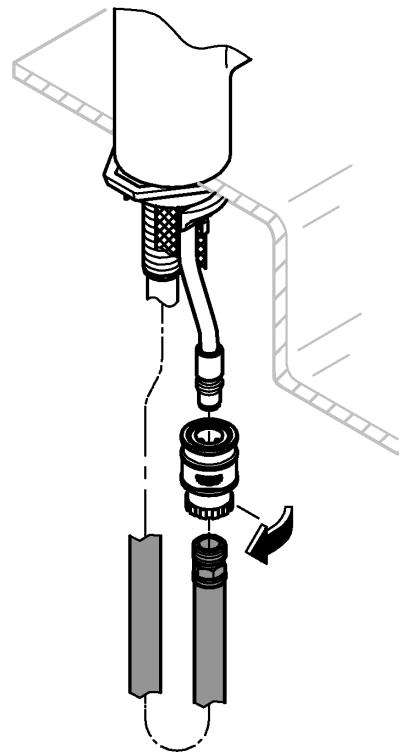

5

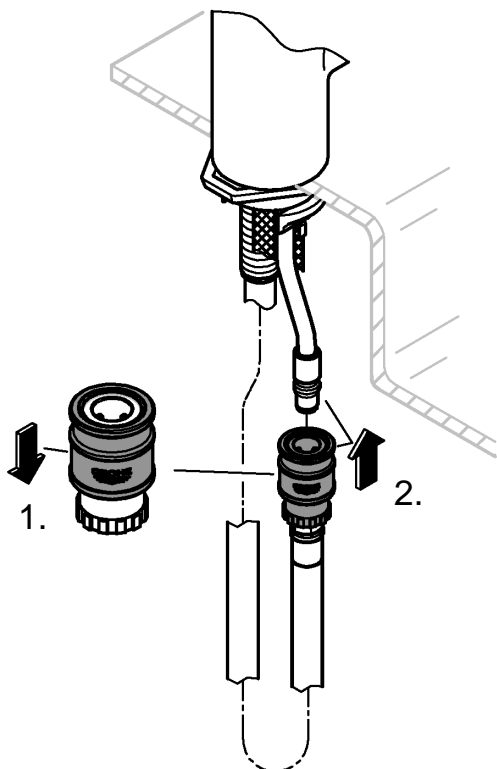

6

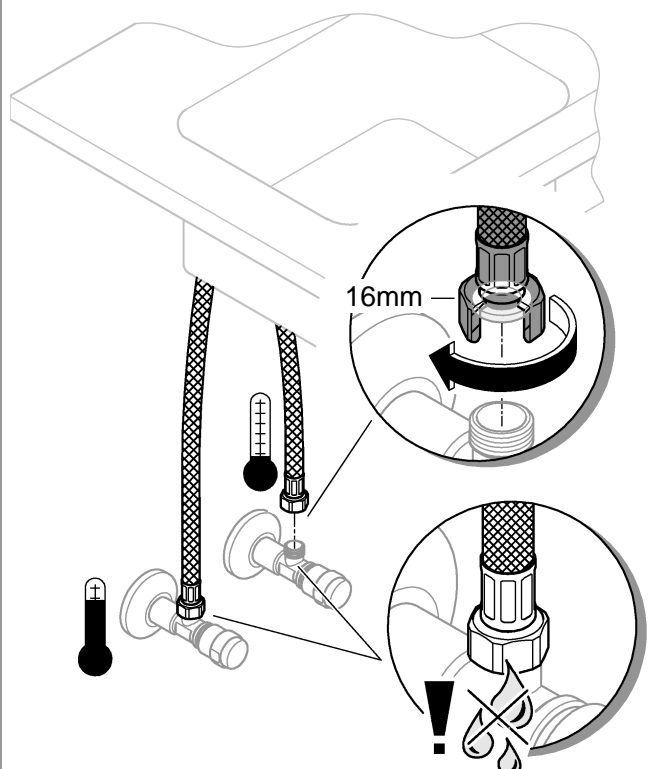



7

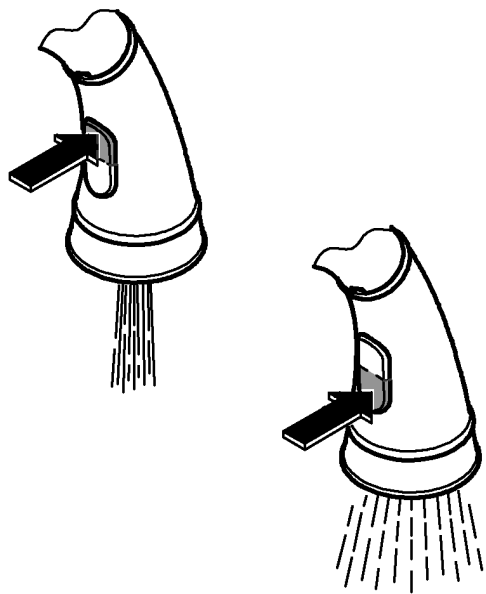
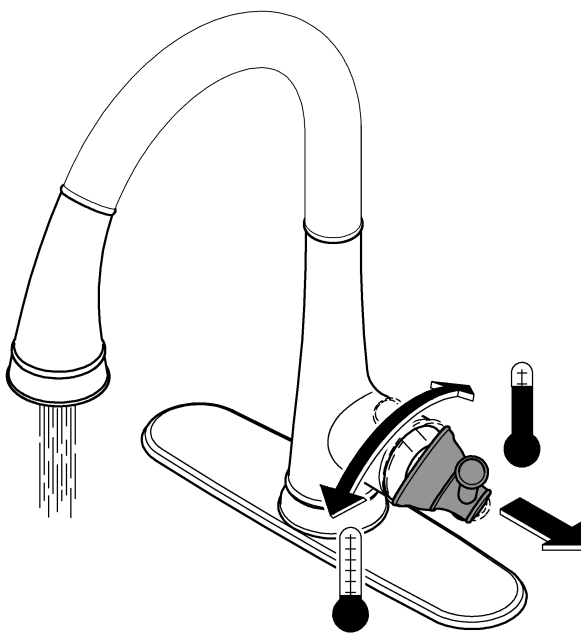
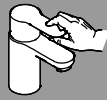
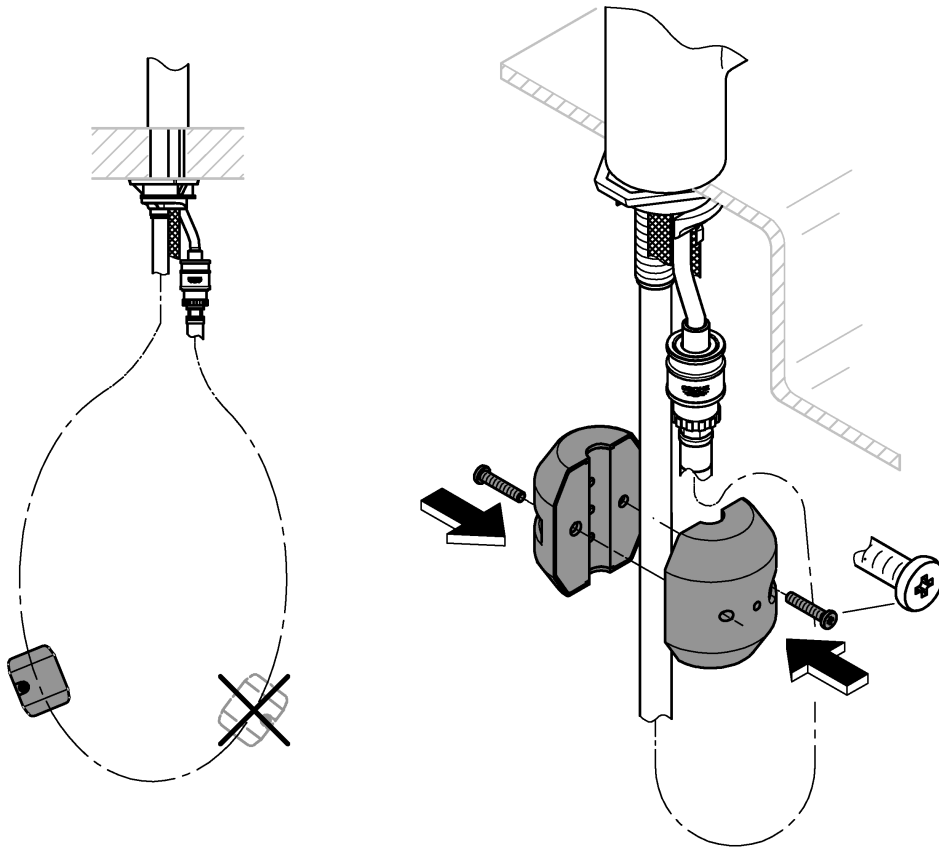

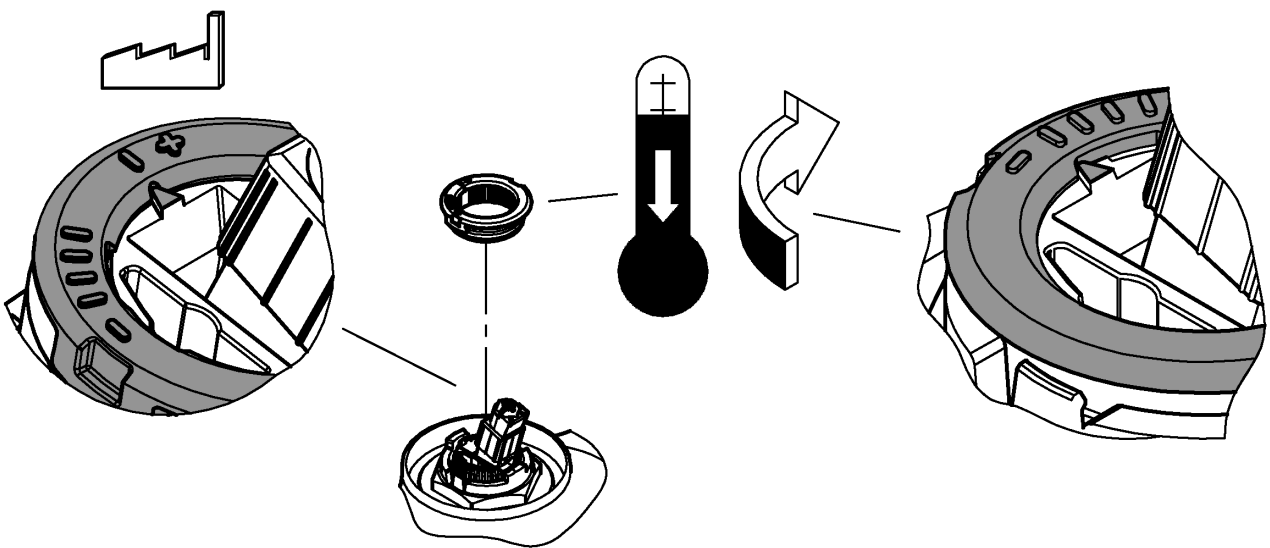
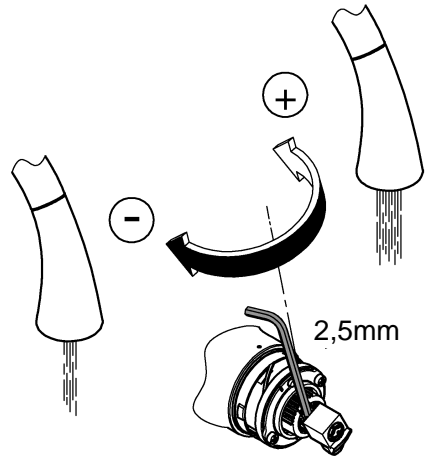
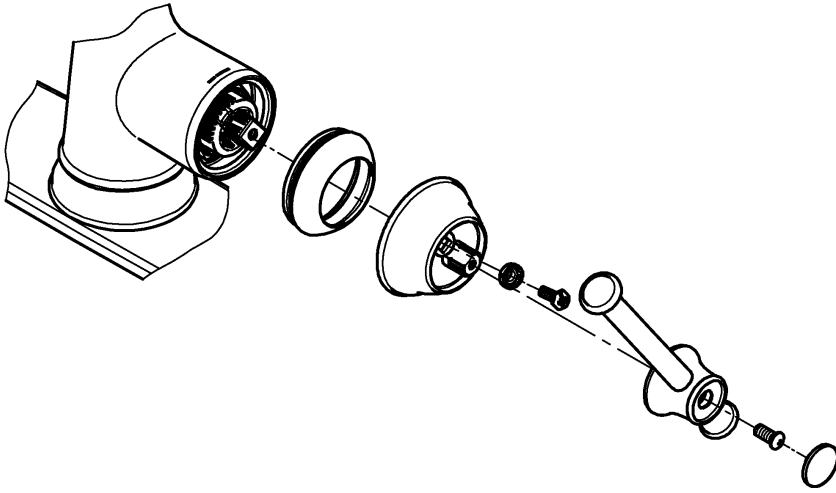



MAINTENANCE 

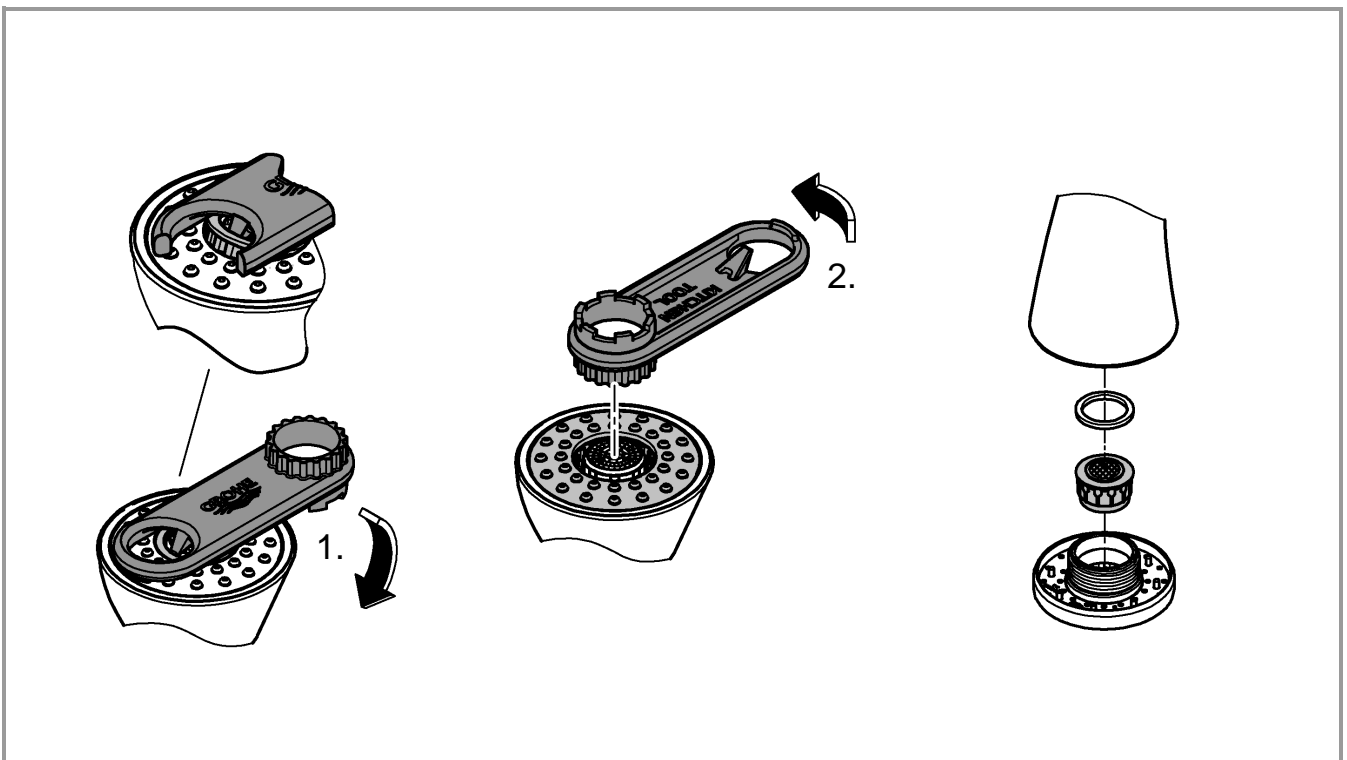
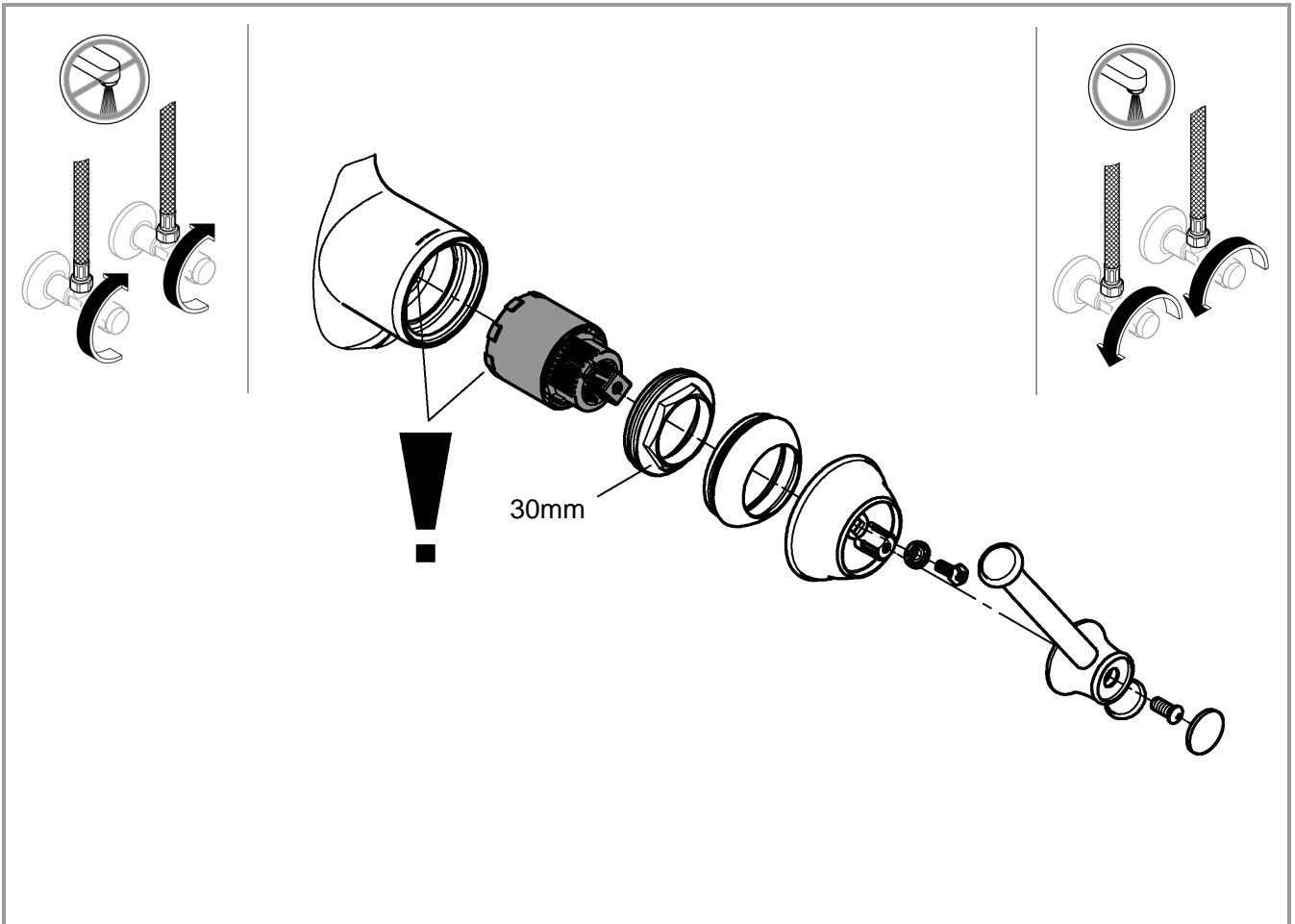

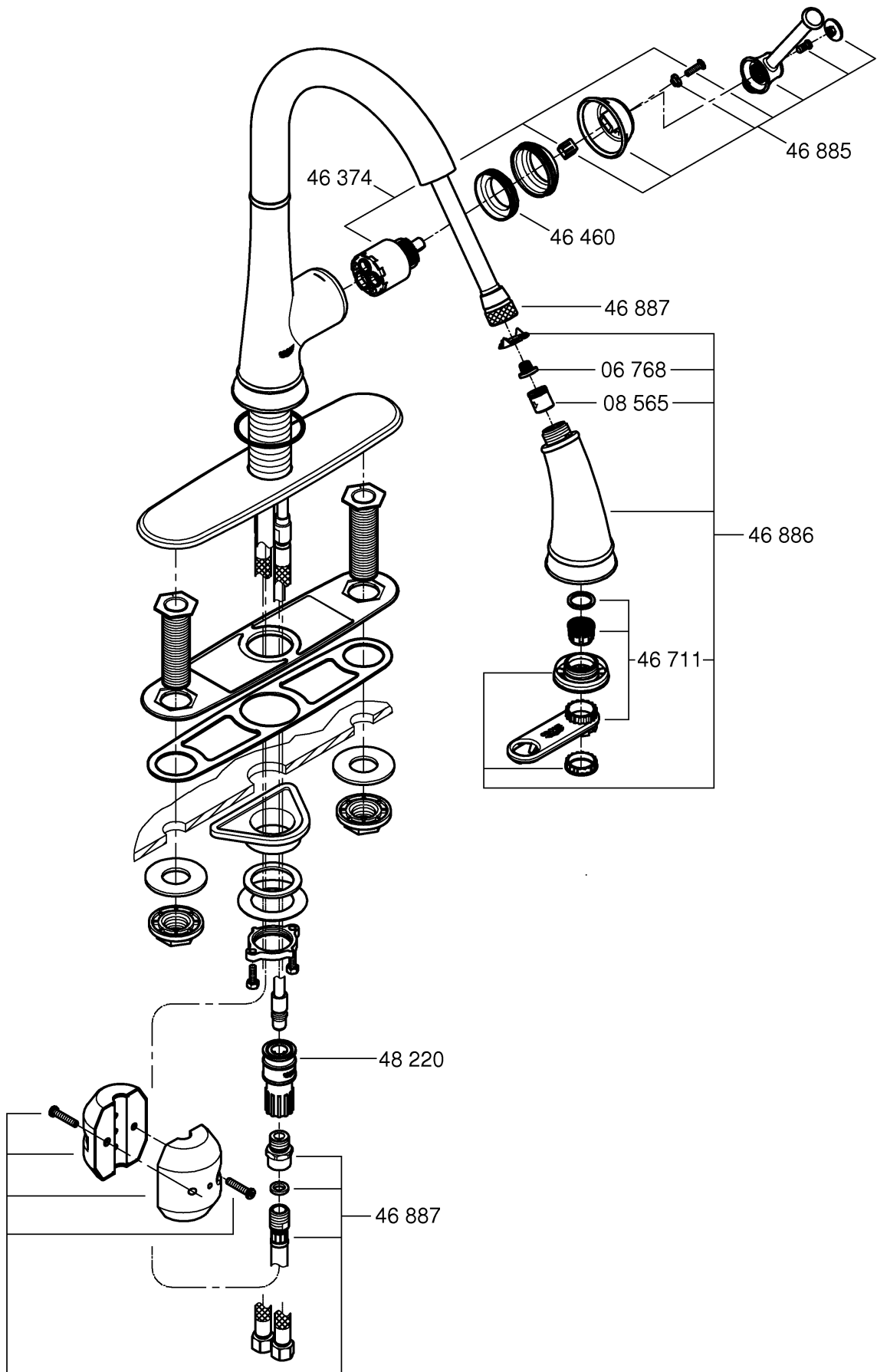

English

Application

Operation is possible in conjunction with:

- Pressurized storage heaters
- Thermally controlled instantaneous heaters
- Hydraulically controlled instantaneous heaters

Operation with low-pressure storage heaters (displacement water heaters) is **not** possible.

Flush piping system prior and after installation of faucet thoroughly!

Specifications

- Max. flow: 6.6 L/min or 1.75 gpm/60 psi
- Flow pressure
 - min.: 7.25 psi
 - recommended: 14.5 - 72.5 psi
 - greater than 72.5 psi, fit pressure reducing valve
- Max. operating pressure: 145 psi
- Test pressure: 232 psi
- Temperature
 - max. (hot water inlet): 158 °F
 - Thermal disinfection possible
- Water connection: cold - RH
hot - LH
- Non reversible cartridge

Notes:

- Major pressure differences between cold and hot water supply should be avoided.
- To be installed according to local codes and regulations.

Care

Instructions for care of this faucet will be found in the Limited Warranty supplement.

Français

Domaine d'application

Le service est possible en combinaison avec:

- Des chauffe-eau à accumulateur sous pression
- Des chauffe-eau instantanés à commande thermique
- Des chauffe-eau instantanés à commande hydraulique

Un service avec des systèmes d'eau chaude à écoulement libre **n'est pas** possible.

Bien rincer les canalisations avant et après l'installation!

Caractéristiques techniques

- Débit maxi.: 6,6 l/min ou 1,75 g/min/4,1 bar
- Pression dynamique
 - mini.: 0,5 bar
 - recommandée: 1 - 5 bar
 - supérieure à 5 bar, mise en place d'un réducteur de pression
- Pression de service maxi.: 10 bar
- Pression d'épreuve: 16 bar
- Température
 - maxi. (admission d'eau chaude): 70 °C
 - Désinfection thermique possible
- Raccord d'eau: froide - à droite
chaude - à gauche
- Cartouche non réversible

Remarques:

- Il convient d'éviter toute différence de pression importante entre l'alimentation en eau chaude froide et chaude.
- A installer conformément aux prescriptions et réglementations locales.

Entretien

Vous trouverez les instructions d'entretien de ce mitigeur dans le supplément Garantie Limitée.

Español

Campo de aplicación

Es posible el funcionamiento en conjunción con:

- Acumuladores de presión
- Calentadores instantáneos con control térmico
- Calentadores instantáneos con control hidráulico

No instalar con acumuladores de baja presión (calentadores de agua sin presión).

¡Purgar a fondo el sistema de tuberías antes y después de la instalación!

Características técnicas

- Caudal máx.: 6,6 L/min o 1,75 gpm/60 psi
- Presión
 - mín.: 7,25 psi
 - recomendada: 14,5 - 72,5 psi
 - si la presión es superior a 72,5 psi, se deberá instalar una válvula reductora de presión
- Presión de utilización máx.: 145 psi
- Presión de verificación: 232 psi
- Temperatura
 - máx. (entrada del agua caliente): 158 °F
 - Desinfección térmica posible
- Acometida del agua: fría - a la derecha
caliente - a la izquierda
- Cartucho irreversible

Notas:

- Deberán evitarse las diferencias de presión entre las acometidas del agua fría y del agua caliente.
- A ser instalado conforme a códigos y reglamentos locales.

Cuidados periódicos

En el suplemento Garantía a Limitada encontrará las instrucciones relativas al cuidado de esta batería.

USA

& +1 800 4447643
us-customerservice@grohe.com

www.grohe.com



CDN

& +1 888 6447643
info@grohe.ca